

The background of the entire page is a blue-tinted image of a space station or satellite in orbit. Overlaid on this are several white and yellow circuit-like lines that start from the left edge and branch out towards the center and right, ending in small circles. These lines are positioned around the main title.

WATTSYS[®] Power distribution system

WATTSYS®

Power distribution systems

As vital components for electrical power distribution in telecommunication satellites and land-based weapon systems, the bus and battery bars developed by AXON® ensure reliable distribution of constant energy.

BUS & BATTERY BARS

Bus and battery bars are used to distribute energy in the different parts of a satellite (see drawing):

- > between the different components of the batteries (e.g. cells, bypass, shunt, connectors.) (1),
- > between the solar array slip ring and the power system regulator (PSR/PCU) (2),
- > between the batteries and the power system regulator (3),
- > between the power supply regulator system and the different devices in the satellite (e.g. computer, power emitter, navigation system, propulsion.) (4),
- > between battery pack groups (5).

AXON's bus and battery bars are composed of silver plated pure aluminium or high conductivity aluminium alloy. They are characterised by their flat shape.

Their main advantages:

- > high electrical conductivity of pure aluminium and aluminium alloy,
- > mass reduction compared to a copper solution,
- > improved heat dissipation in comparison with a circular power cable bundle,
- > significant improvement in voltage drop throughout the power distribution chain.

Numerous satellites of the EUROSTAR 3000 platform have been equipped with AXON's bus and battery bars and have been in orbit for more than 10 years: e.g. ASTRA, ARABSAT, INTELSAT, SKYNET.

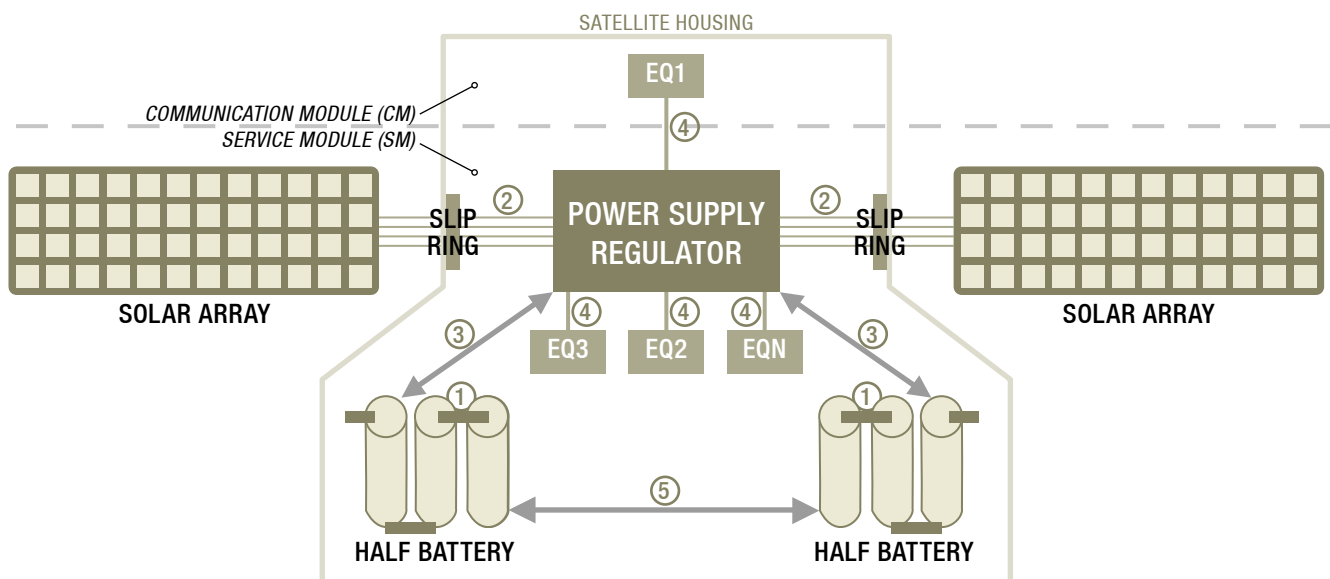

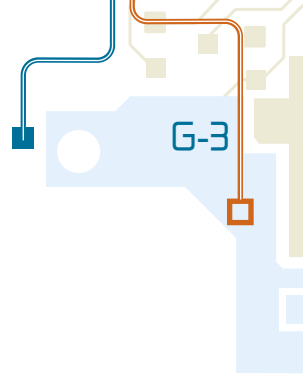

The construction of the bars can be single or multi-layer.
 Depending on the application, different types of bars can be studied for specific applications.
 Below is a description of the main shapes qualified by AXON'.
 Other shapes can be studied for specific applications.

Flat cables: Monolayer inter cell battery bars.



- Silver plated aluminium alloy
- Wrapped polyimide adhesive tape (50% overlap)

Type U: Multilayer bar for the link between the solar arrays and the power system regulator.

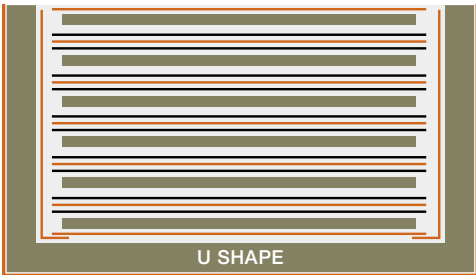

- Polyimide tape
- Prepreg glass fibre
- Silver plated aluminium alloy
- Epoxy filling

U SHAPE

Type E: Monolayer bar for the link between the batteries and the power system regulator.

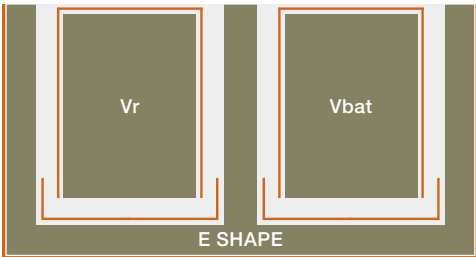

- Polyimide tape
- Silver plated aluminium alloy
- Epoxy filling

E SHAPE

Type I: Monolayer bar for the link between the power system regulator and the different satellite devices.



- Silver plated pure aluminium
- Epoxy coating
- Silicone potting



MONOLAYER BAR TYPE E



MONOLAYER BAR TYPE I



FLAT CABLE TYPE

MAIN CHARACTERISTICS

Type of bar (indicative values)

These bars shapes and sections are not frozen and can be matched to customer needs.

	RESISTANCE MAX (mΩ/m)	MAXIMUM DERATED CURRENT (A)	RATED VOLTAGE (V _{DC})	MAX. NON OPERATING TEMP. (°C)	SECTION (mm ²)	@T° MAX (°C)
Bus bar Type U (0v shape) 31mm x 18mm (9 layers)	0.201	200	100	120	184	105
<i>U (Layer) 0.8mm x 23mm</i> (each internal layer)	1.52	22	100	120	18.4	105
Bus bar Type E (0v shape) 28 x 24.8mm	0.17	300	100	120	224	85
Bus bar Type I version 8mm x 23mm (each internal layer of E shape bars)	0.186	200	100	120	184	85
Bus bar Type I version 3mm x 23mm (free I shape)	0.406	80	100	120	69	105
Flat cables (battery bars) 3mm x 40mm	0.233	300	100	180**	120	150*
Flat cables (battery bars) 4mm x 40mm	0.175	400	100	180**	160	150*
Flat cables (battery bars) 5mm x 40mm	0.160	500	100	180**	200	150

*: 110°C if a connector is bounded by soft soldering.

** : Without connectors.

For other bar shapes please contact us.

Type of connection (indicative values)

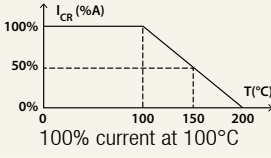
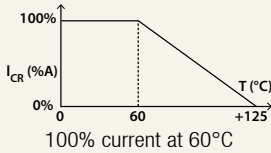
	MAX. CONTACT RESISTANCE (mΩ/m)	MAXIMUM DERATED CURRENT (A)	RATED VOLTAGE (V _{DC})	@T° MAX (°C)	SIZE (overall dimensions in mm)	PARAMETER DERATING INFORMATION
MMC (AXON® Micro Modular Connectors). Inline variant.	≤ 2.5	40* per contact	250	200	36 x 9 (4 contacts size)**	
MMC (AXON® Micro Modular Connectors). PCB variant.	≤ 2.5	25* per contact	250	200	36 x 9 (4 contacts size)**	100% current at 100°C
Bolted interface (4 screws M4) e.g. flat cable (battery bar) terminations	≤ 0.02	400*	100	150	40 x 10 (contact surface without housing)**	100% current at 150°C
Space approved power D-Sub connector xWx	≤ 2.5 per contact	40* per contact	300	125	53 x 12 (4 contacts size)**	
Space approved standard D-Sub connector	≤ 5 per contact	7.5* per contact	300	125	53 x 12 (4 contacts size)**	100% current at 60°C

*: See parameter derating information.

** : Please contact us for more information.

Other connector types are possible on request.

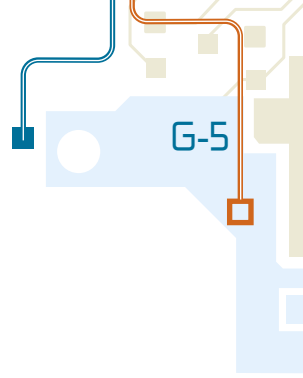

Flexible links and braid

Example of wires used for flexible links (indicative values)

	RESIS-TANCE (mΩ/m)	MAXIMUM CURRENT PER CONDUCTOR (A)	RATED VOLTAGE (V _{DC})	@T° MAX (°C)	SECTION (mm ²)	PARAMETER DERATING INFORMATION (ALLOWABLE CURRENT)
ESA wire AWG12* ESCC 3901 001 31 (QPL)	6.03	23	600	200	3.2	
ESA wire AWG16* ESCC 3901 001 29 (QPL)	14.3	13	600	200	1.3	
ESA wire AWG20* ESCC 3901 002 59 (QPL)	32.2	7.5	600	200	0.6	
Power isolated copper braid P/N: P540409	0.3	200	100	200	62	100% current at 70°C 85% current at 85°C

* refer to AXON's ESA qualified ESCC cables for more information.
Other sections available on request.

GENERAL CHARACTERISTICS (ALL TYPE OF BARS)

CHARACTERISTICS	VALUE
Low outgassing materials	TML (Total Mass Loss) <1% CVCVM (Collected Volatile Condensable Material) <0.1%
Operating temperature	-35°C to +85°C (for flat cables: -35°C to +150°C)
Qualification temperature	-40°C to +110°C
Insulation resistance between bars	> 1000 MΩ under 500 V _{DC}
Maximum capacitance between bars	4 nF/m
Emissivity of bar surface	> 0.65

For all types of bars a double electrical insulation is effected between two conductors with different types of insulating materials:

- Silicone + epoxy,
- Epoxy + polyimide tape,....

in order to guarantee an excellent insulation.

Heat resistance of bars is optimised:

- Flat bar shapes (surface increased = better heat dissipation)
- Outer surface insulation (thermal radiation improved)
- Low insulation thickness (thermal conduction improved)



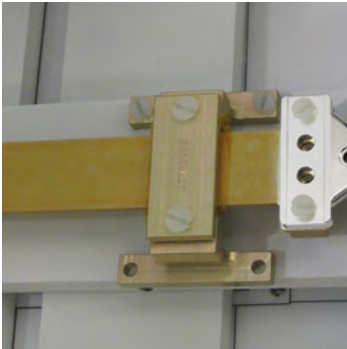

RIGID FIXTURE FOR THIN BAR

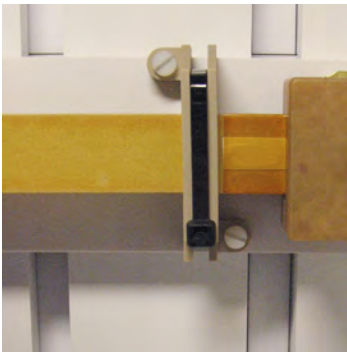

FLEXIBLE FIXTURE FOR THIN BAR

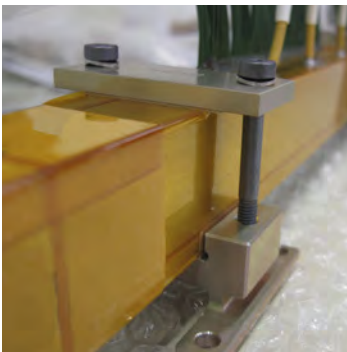

RIGID FIXTURE FOR THICK BAR



FLEXIBLE FIXTURE FOR THICK BAR

FIXING OF THE BARS IN THE SPACECRAFT

In order to install the bus bars onto the spacecraft walls, both rigid aluminium fixtures and flexible fixtures made of high performance thermoplastic polymers or aluminium assemblies are used. These significantly help to reduce the mechanical impact of vibration, shock and temperature. To mount the bar AXON' recommends one rigid and several flexible fixtures placed every 200 mm (7.9").

Flexible fixturing allows the bar to flex with the spacecraft movement, taking into account its thermo-elastic behaviour. Rigid support ensures complete fastening of the bar to the mechanical structure.

Installation of fixtures and bars are carried out according to the applicable customer specification.

EXAMPLE OF FIXTURING FOR "I"-SHAPE BAR

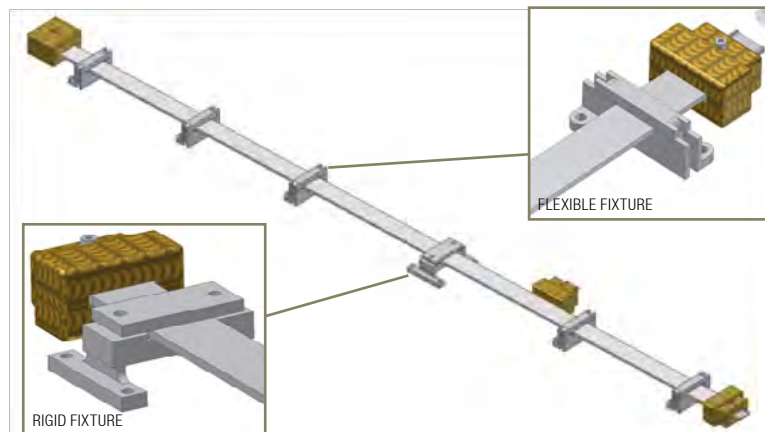

EXAMPLE OF FIXTURING FOR "E"-SHAPE BAR

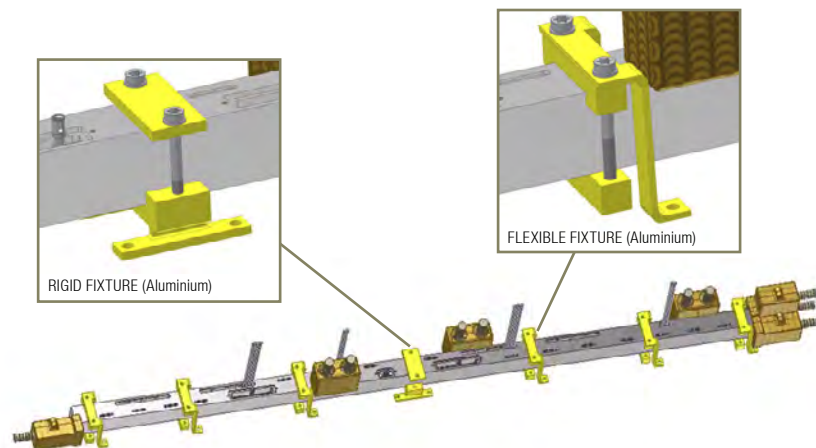

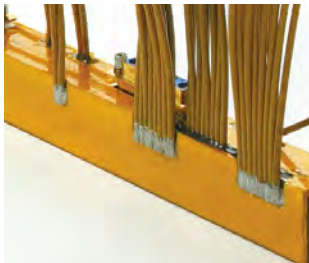
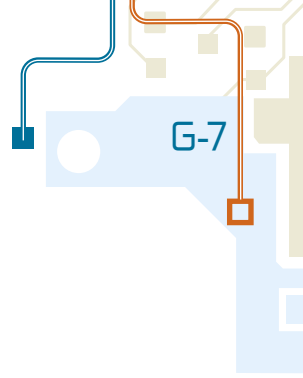

WIRES SOLDERED TO THE BAR



FLEXIBLE COPPER POWER BRAID

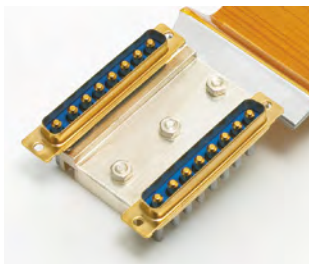

CONTACT WELDED ONTO THE BARS

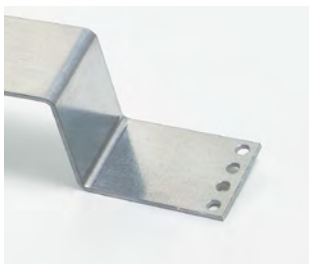

BOLTED CONNECTION



AXON' MICRO MODULAR CONNECTORS

BAR INTERCONNECTION

The bar can be connected via many different connectors and wires with different gauge sizes. The interconnection of Wattsys® bar is carried out with dismantable flexible or rigid links:

Dismountable flexible links:

- › Wire bundles (e.g. ECSS wires) soldered to the bars,
- › Flexible copper power braids.

Dismountable rigid terminations:

- › Contacts welded onto the bars (compatible with standard connectors),
- › Bolted connections (low contact resistance),
- › AXON' power connectors (low size).
- › AXON' Micro Modular Connectors (MMC).

The fixations of the bars (mechanical parts: e.g. screws, washers, machined parts.) have been designed to allow for either:

- a very tight mechanical connection of the bar (rigid fixation: no movement), or
- a flexible mechanical connection allowing for thermo elasticity (flexible fixation).

MANUFACTURING

Production of AXON's bus and battery bars is carried out under cleanroom conditions

- › Cleanliness level: Class ISO 8 = Class 100 000 according to FED STD 209E.
- › For soldering and crimping processes the operators are qualified according to ECSS-Q-ST-70-08 & ECSS-Q-ST-70-26.

The length and routing of the bars can be verified on a 3D mock-up.

QUALIFICATIONS

Various tests are carried out either in AXON's in-house test laboratory or in specialised test facilities outside the company.

AXON' has been approved by the CNES (French space agency) for manual wire crimping and welding according to PID CNES-PID-05-AXON (refer to CNES N° ASF 13-42).

Thermal tests:

- › 1000 hours at 120°C,
- › 100 thermal cycles at -30/+120°C with on/off current cycles,
- › 2000 thermal cycles at -20/+90°C with on/off current cycles.

Vibration tests:

- › Launcher spectrum in X,Y & Z axes,
- › Vibrations on satellite qualification model.

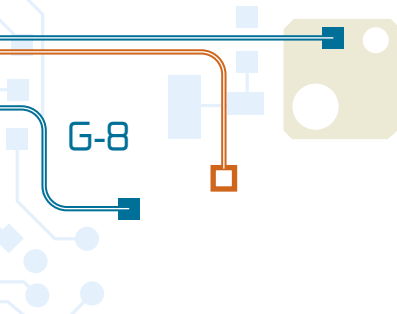

Thermal Vacuum:

- › Vacuum thermal cycles at -40/+110°C with on/off current cycles.

Mechanical test:

- › Mounting/dismounting (for MCP & Bolted interfaces).

Non destructive investigations:

- › Ultrasound cartography: to evaluate uniformity of layer pasting,
- › Tomography (X-ray cartography): to verify the position of layers inside the shape.

Destructive investigations:

- › Scanning Electronic Microscope (SEM):
 - to verify wires & contact soldering,
 - to verify layer pasting & positioning,
- › Differential Scanning Calorimetry polymer analyser: to verify the curing of adhesives.

SERVICE

AXON' provides after-sales service for the whole assembly and can assist on-site to help with integration and updating of the bars. Various installation documents can be supplied on request.

GUARANTY

AXON' bus and battery bars are guaranteed for 15 years use in orbit in addition to 5 years of storage.



3D MOCK-UP



MANUFACTURING OF BUS BARS IN CLEANROOM